

كلنا
مسؤول

ابق
هادئاً
العب و امرح
و
اغسل يديك
بوم بوم بوم بوم

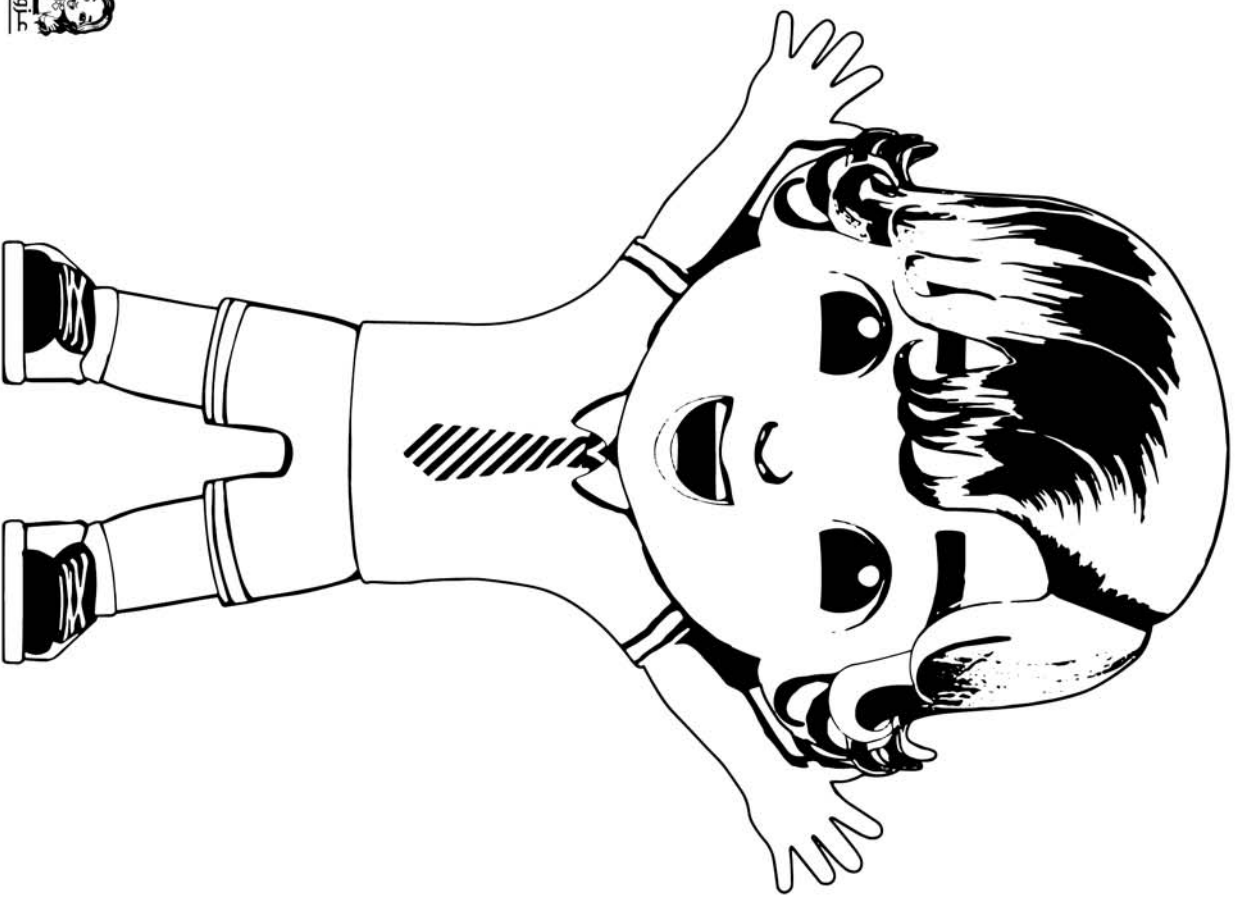

أغسل يدي و ألون كما يطلو لي



أغسل يدي و ألون كما يخلو لي

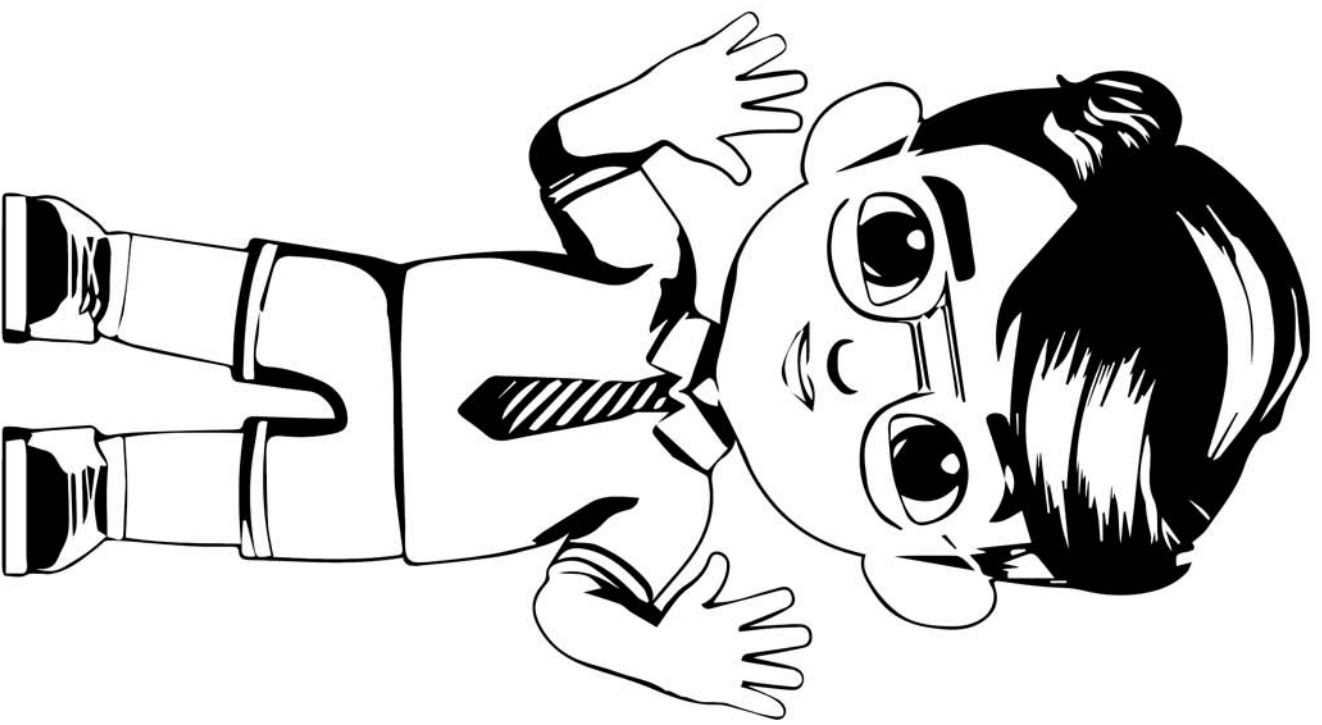
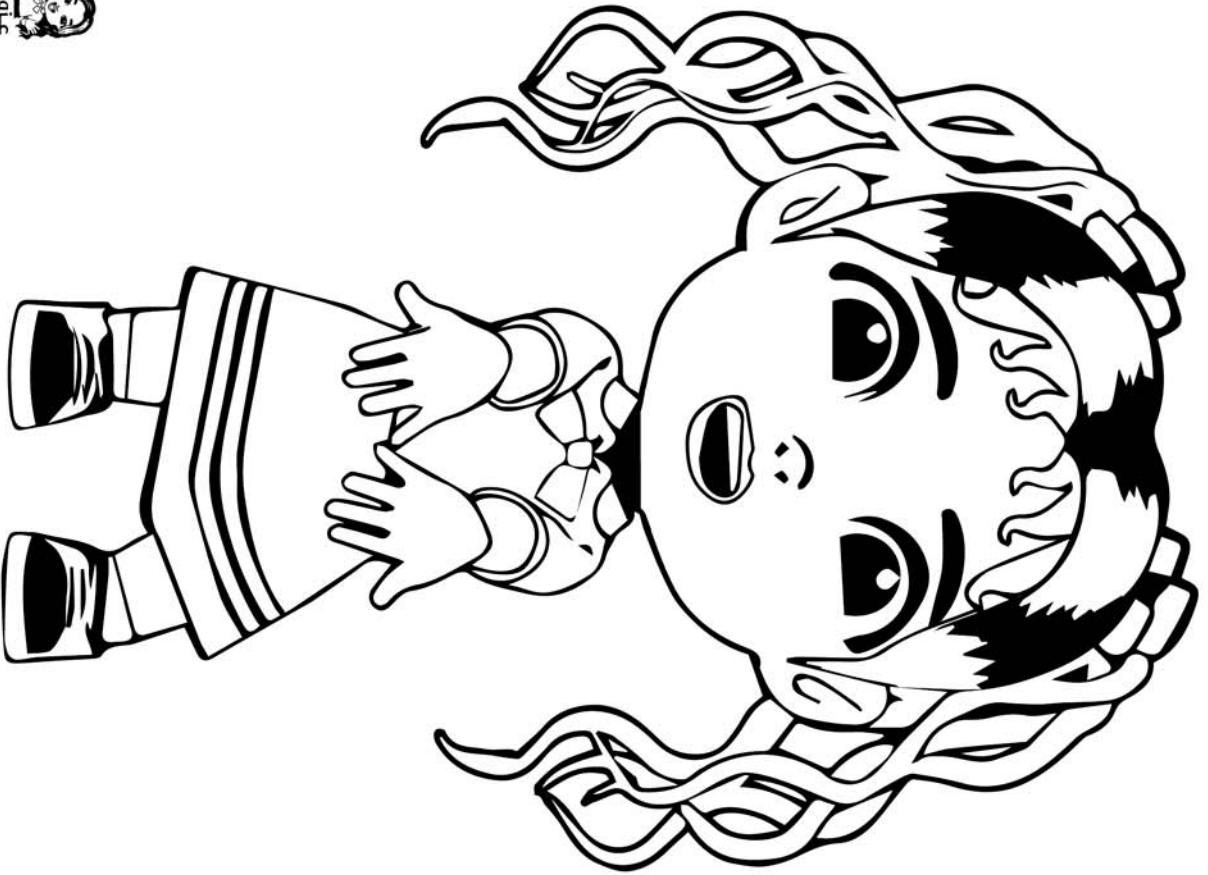



الفعل الخاطئ



أُخرج من المنزل



ألمس وجهي



أكل طعامًا غير صحي



أسهر ليلًا



الفعل الصحيح



ألزم المنزل



أغسل يدي بالصابون و
المصابون



أكل الطعام الصحي



أنام مبكرًا





أَتَتَبِعُ الخَطَ لِأَصْلِ بَيْنَ الأَشْخَاصِ



البداية



البداية



البداية



البداية

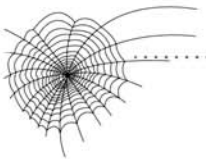

البداية

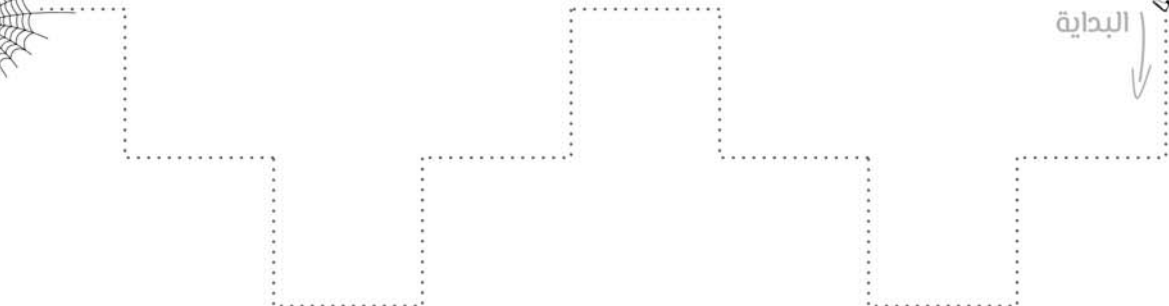



أَتَّبِعِ الخَطَ لِرِسْمِ الأشْكَالِ

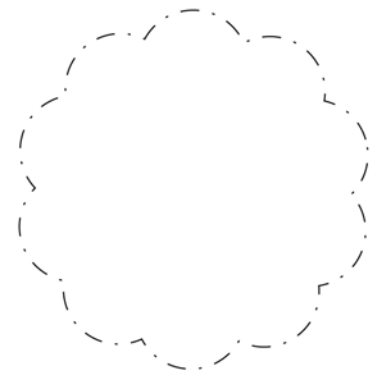
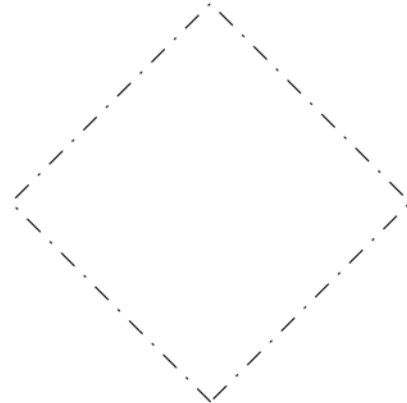
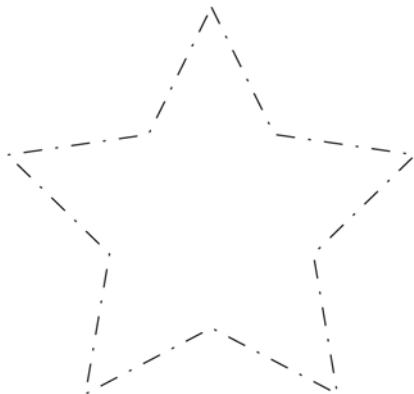
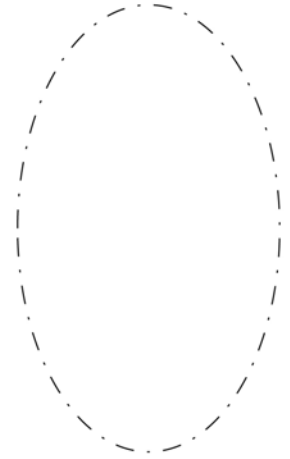
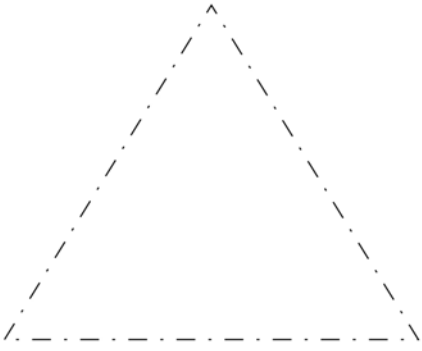
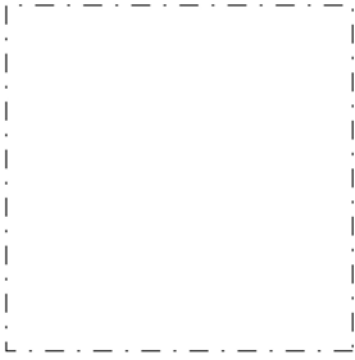
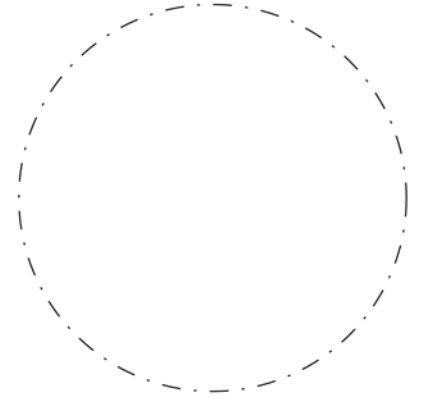
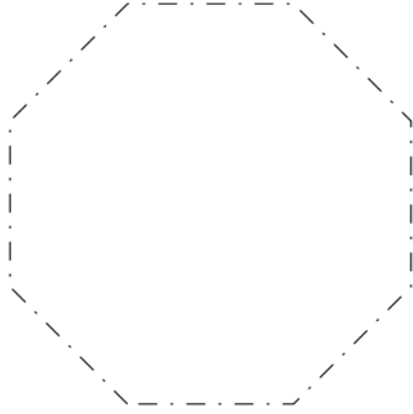
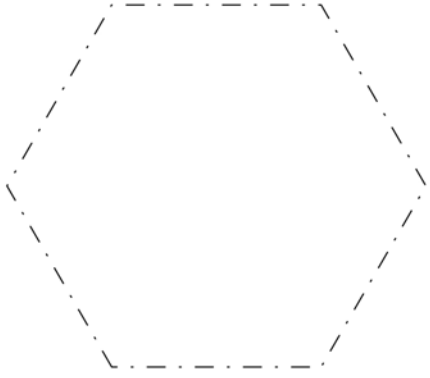

أصل الحيوان مع طعامه المناسب

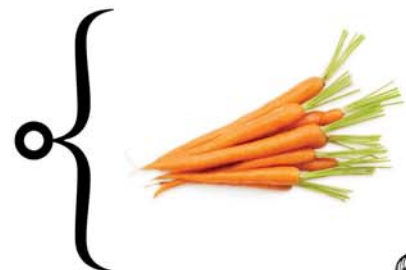
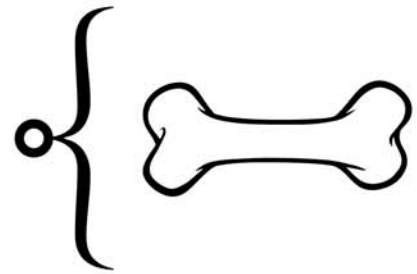
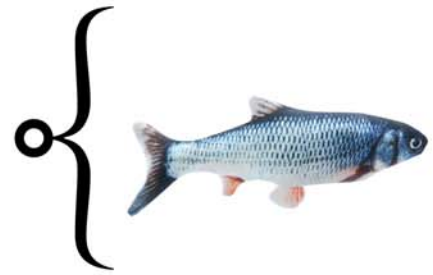

ألون الحروف و الأشكال

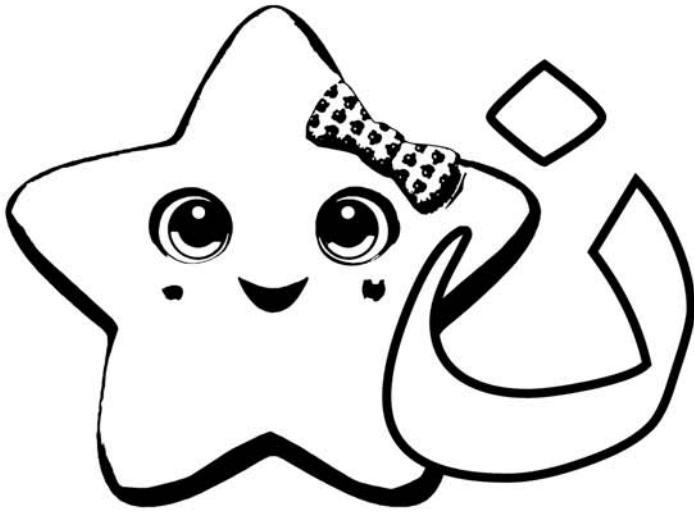
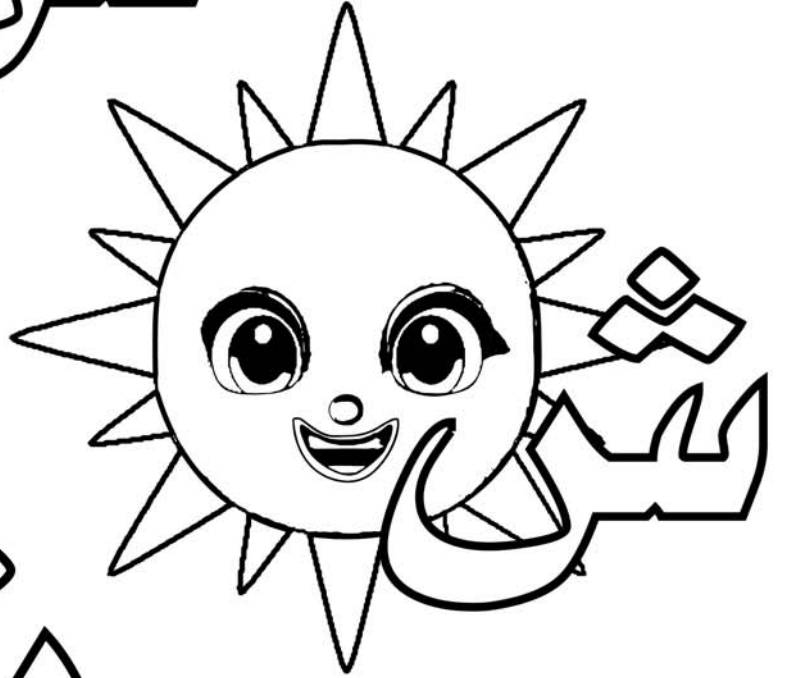
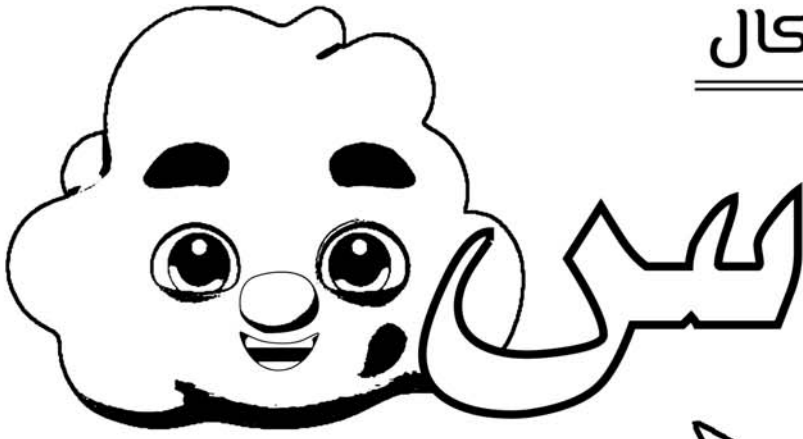

ألون الصورة كما يحلو لي

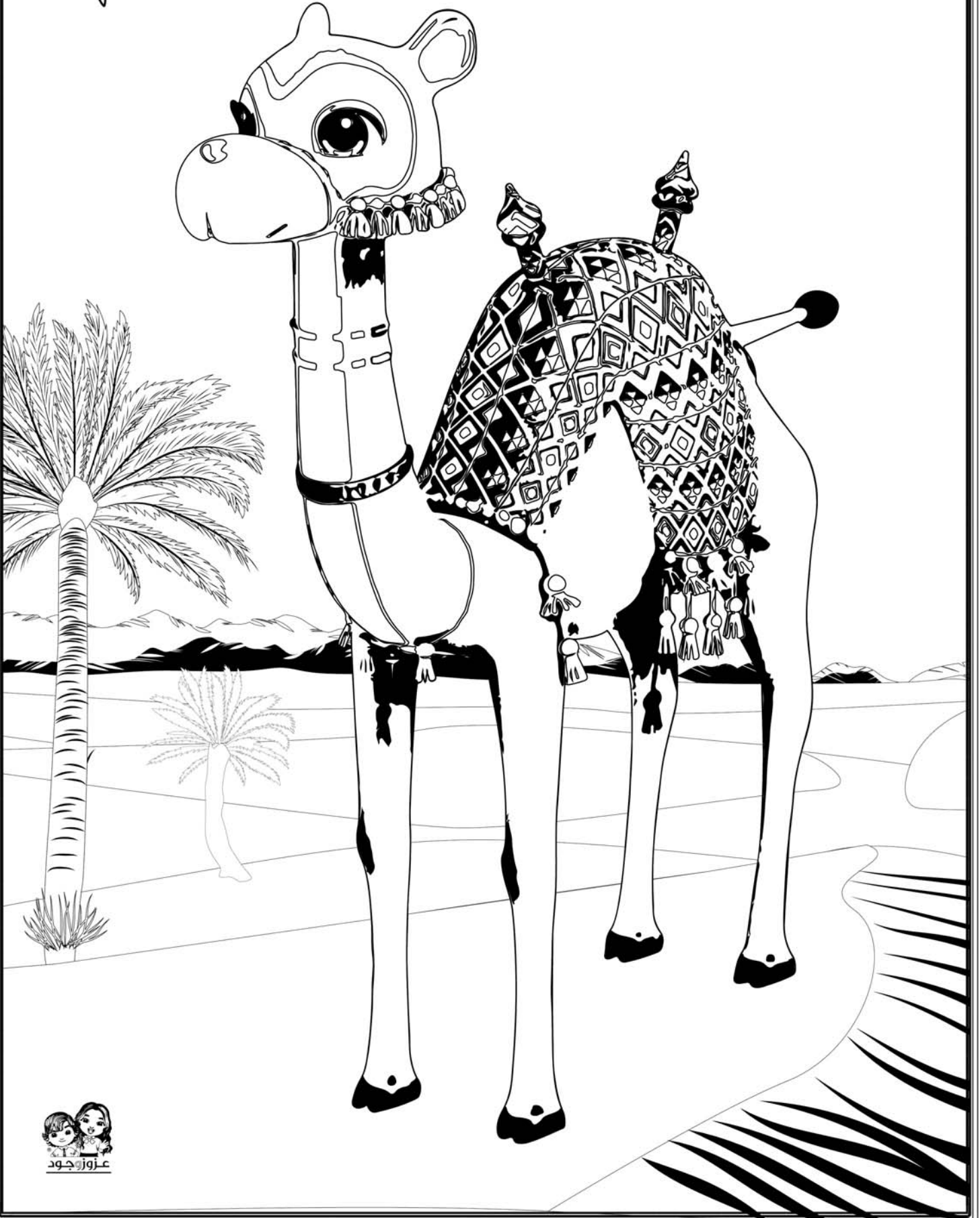
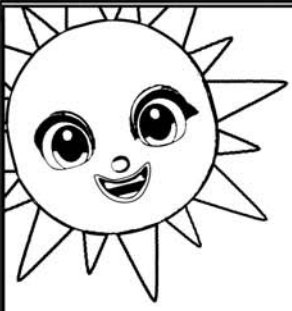

عزوز جود



ألصق " الرقم " في مكانه المناسب بالترتيب



	٤		٢	١
١٠	٩			
١٥	١٤		١٢	
	١٩	١٨		

٣	٥	٦	٧	٨
١١	١٣	١٦	١٧	٢٠

أقص و ألق لتكتمل صورة عزوز

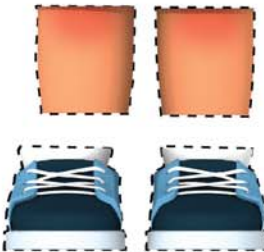
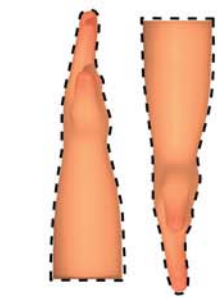
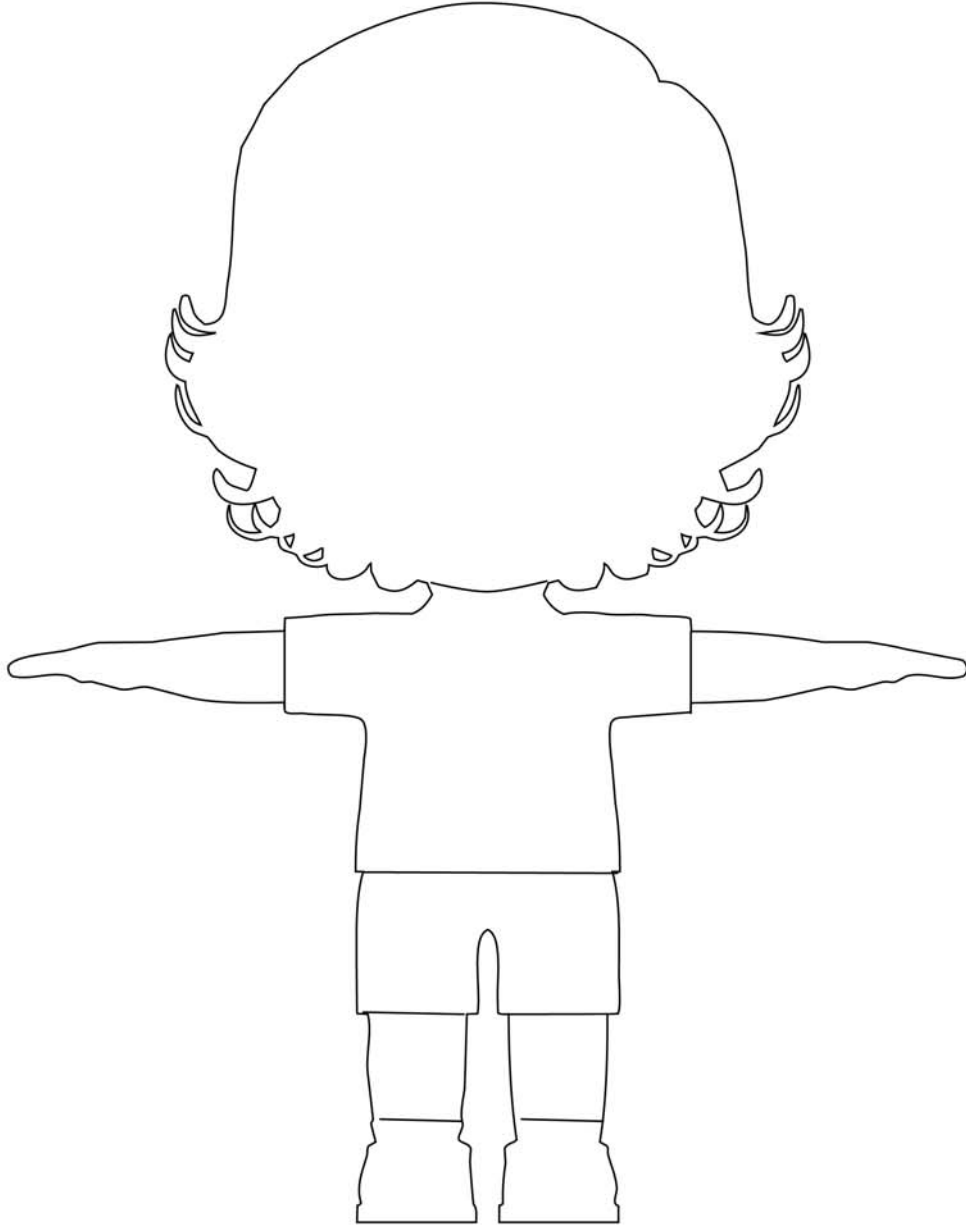

العيان

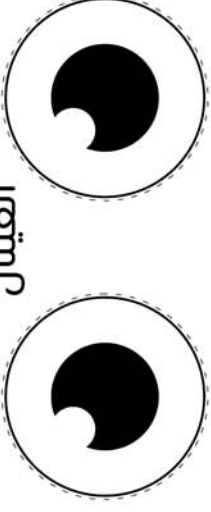

المبسم



الشكل النهائي



الجسم

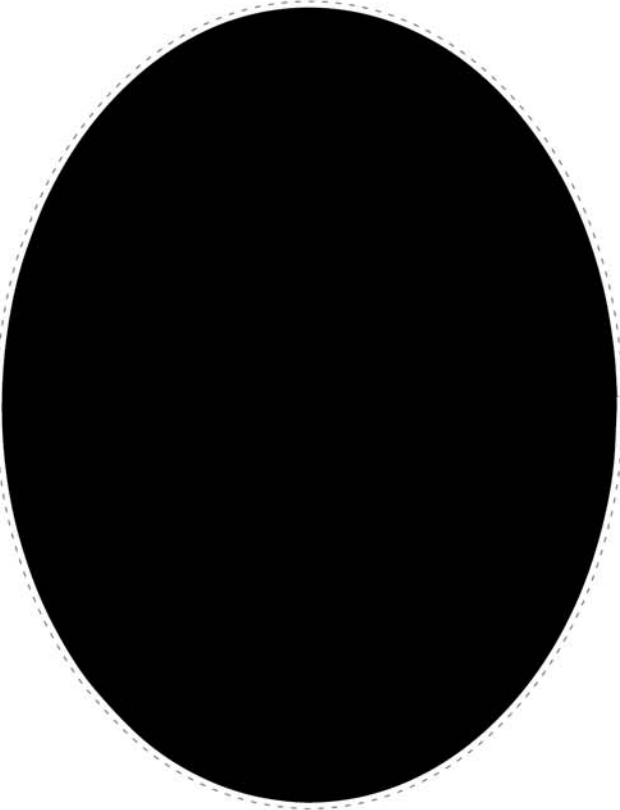

الأرجل

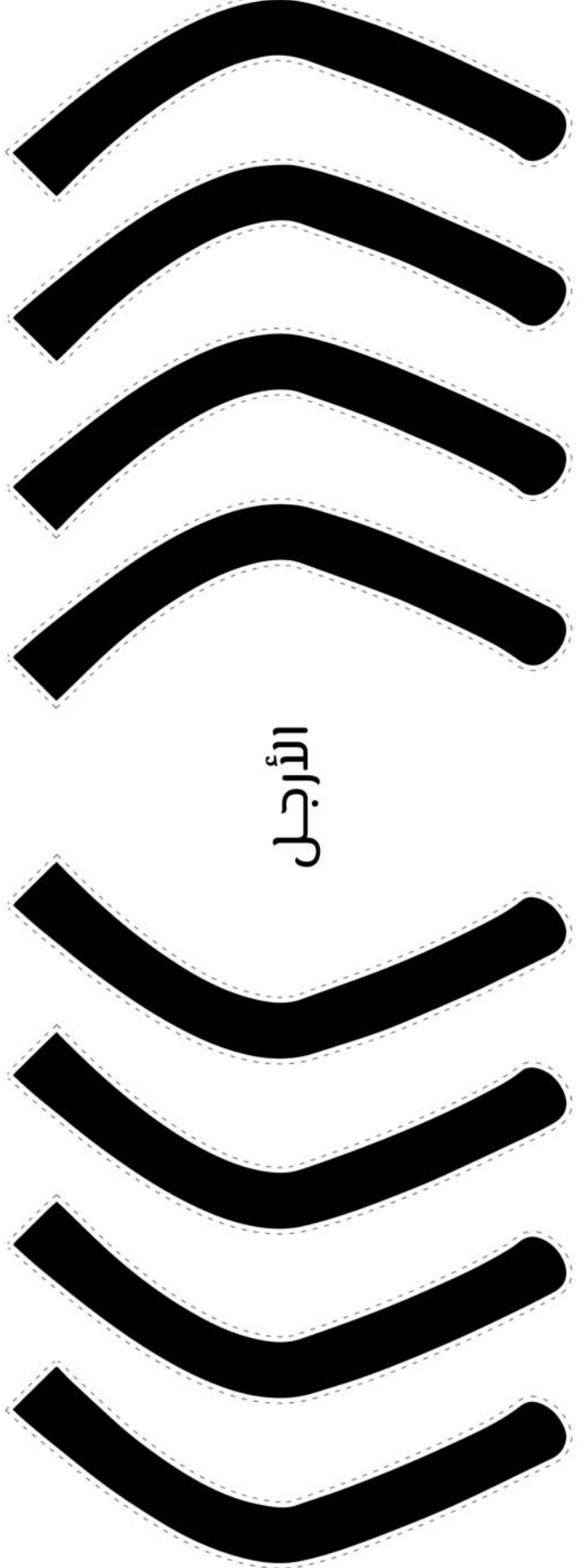



أرسم المشاعر المناسبة للكلمة



متفاجيء



حزن



غضب



سعادة

ألون الصورة كما يحلو لي



أقص و أصنع القناع الهوائي للعبتي

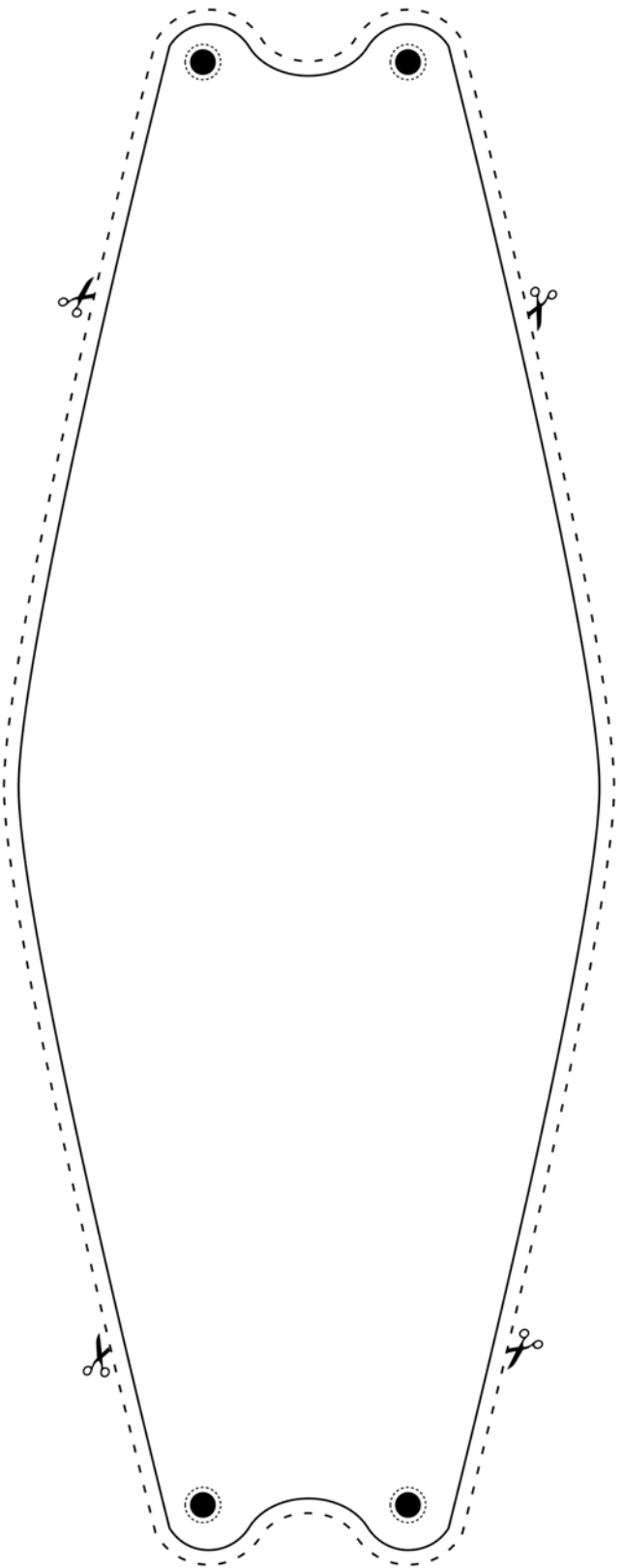

أقص و أصنع علبة سناديل

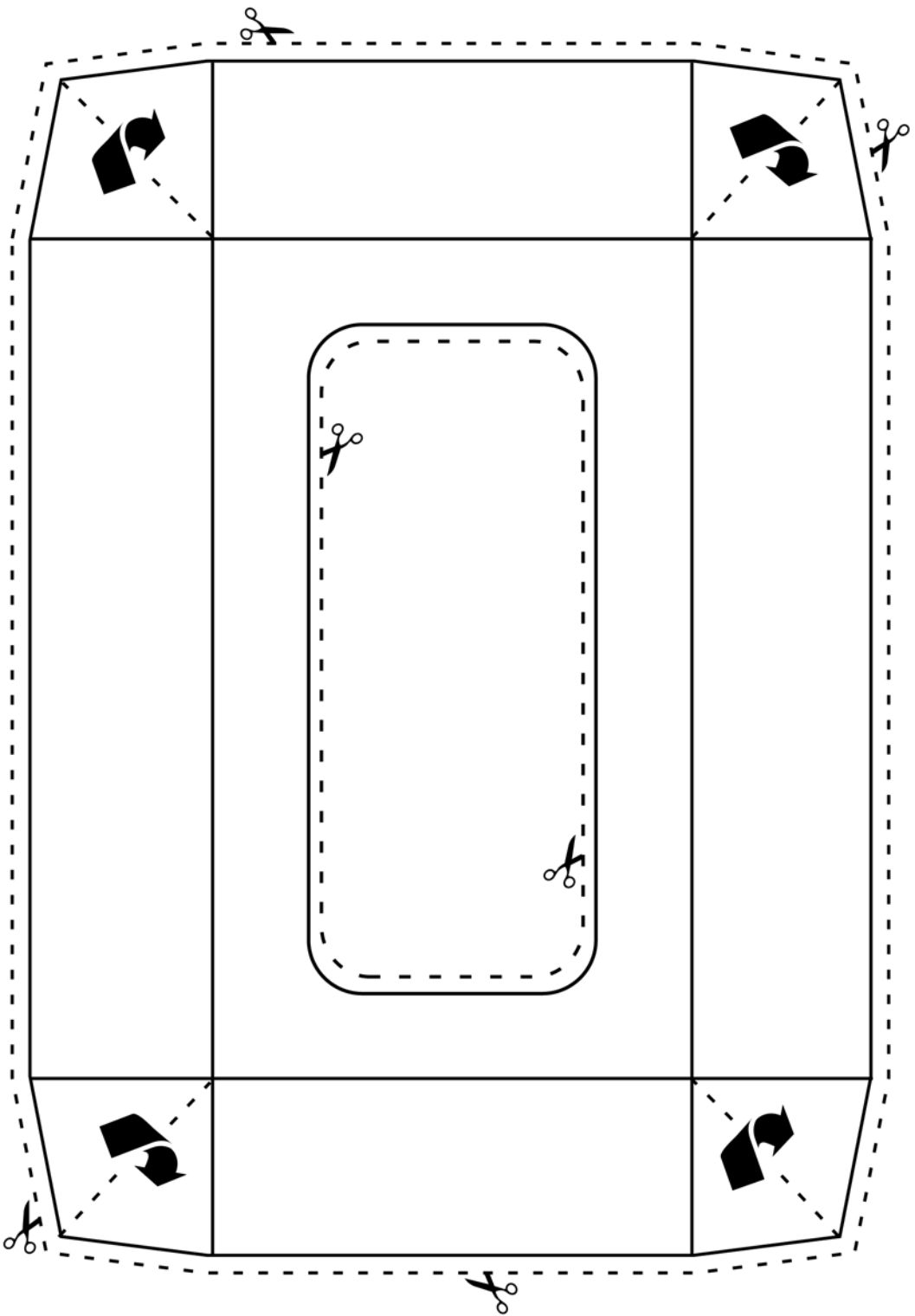

أقص و أصنع قارورة التسقيم

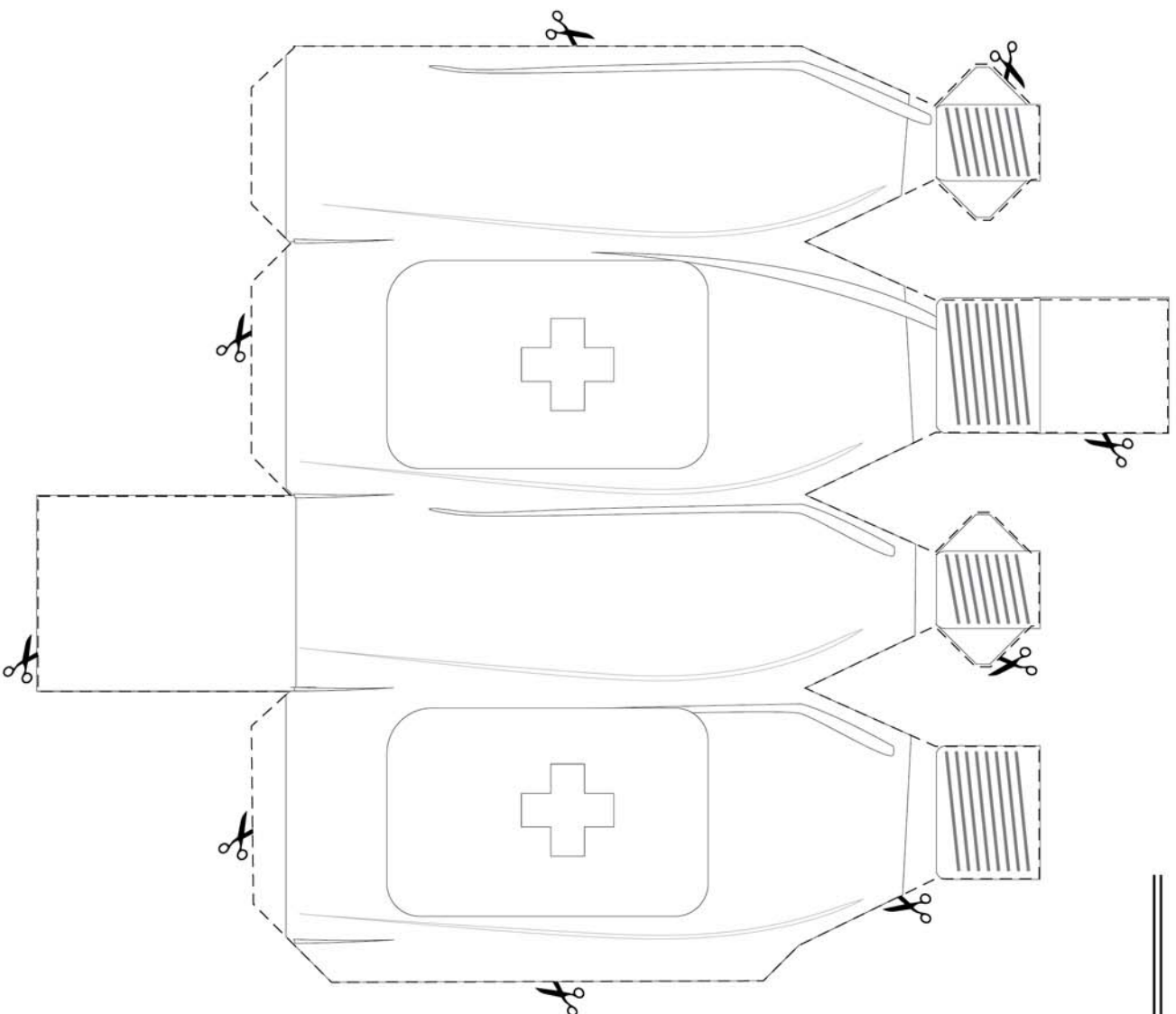

أصمم قطعة الصابون

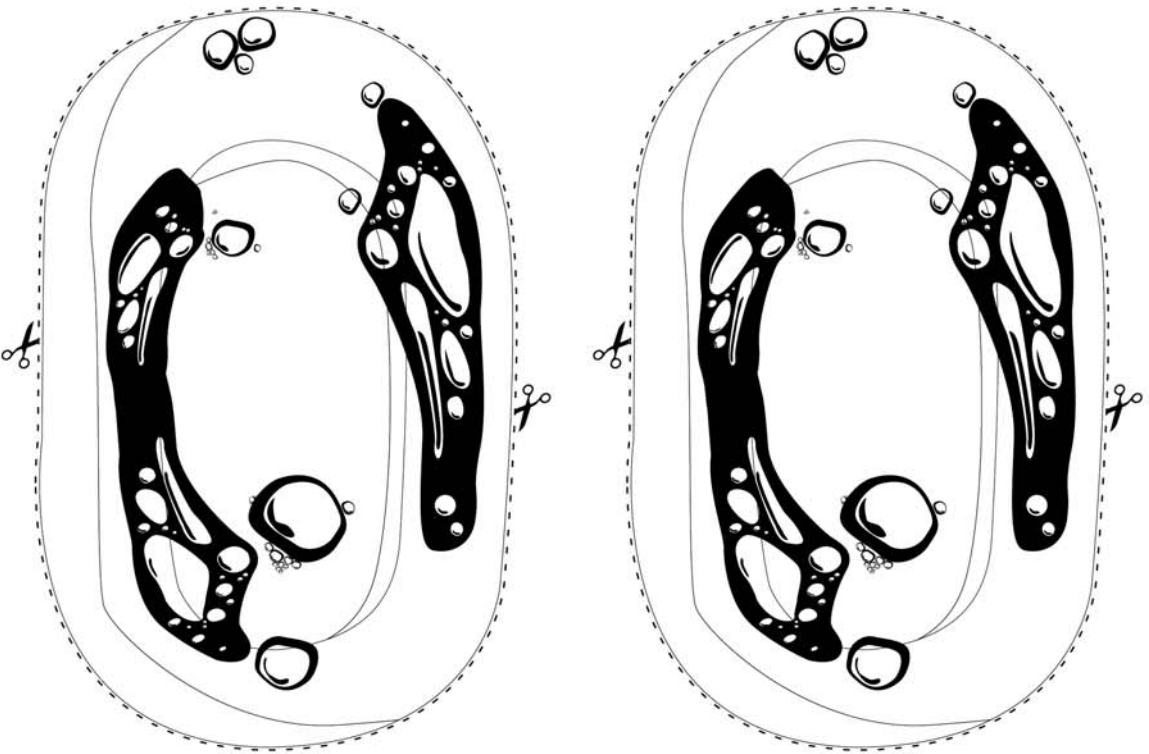
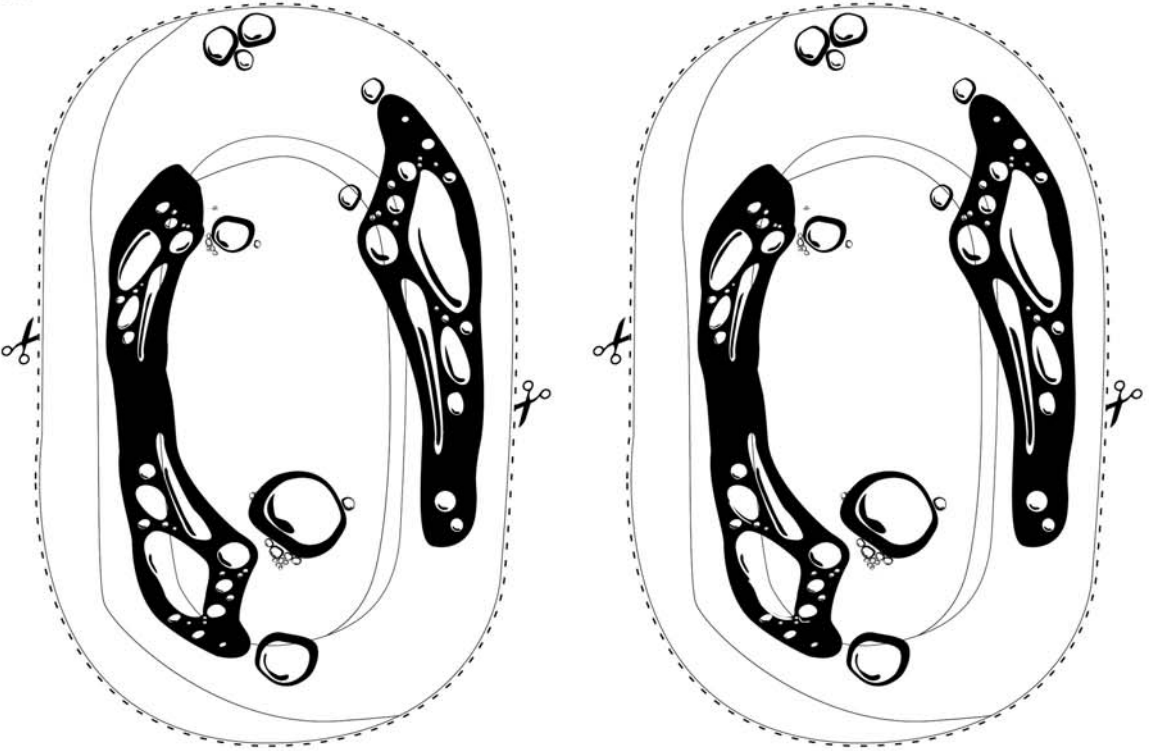



أنا



رأيت الممیزل للأدمی عائلتی

التاریخ :



عزوز جود
/Azoozandjude
/Azoozandjude